

Notes on Electrical Safety



職業安全健康局
OCCUPATIONAL SAFETY & HEALTH COUNCIL



Booklet content



Contents

Page

1. Introduction	3
2. Electrical safety legislation	4
3. Sources of electricity	5
4. Electricity principles	6
5. Electrical hazards	7
6. Special process (electric arc welding)	9
7. Protective measures for prevention of direct electrical contact	10
8. Safety devices	11
9. Safe use of electricity	13
10. Installation and maintenance of electrical work	17
11. First-aid for electric shock	18
Attachment: Inspection checklist of electrical safety	19

Note:

- The information contained in this booklet and the attachment is for reference only, and is subject to any appropriate adjustments related to the situation of your own working environment.
- This booklet is also available in Chinese version





1. Introduction



As a source of power, electricity is used in all aspects of life. In the home and at work, electricity provides the power for everything from domestic appliances to industrial machines, from office equipment to electric tools. When compared to the potential dangers of machinery and chemical substances, electrical hazards can be easily overlooked. Unfortunately, this neglect often causes serious accidents and loss of property. Many of these accidents can be prevented as they are mainly caused by electricity users who lack basic safety awareness.





2. Electrical safety legislation



The legislation involving electrical safety is the “Electricity Ordinance (Chapter 406)” as enforced by the Electrical and Mechanical Services Department and “Factories and Industrial Undertakings (Electricity) Regulations (Chapter 59)” enforced by the Labour Department.

2.1 Electricity Ordinance

The Ordinance requires that people engaged in electricity work, or with contractors and electricity generation facilities, must be registered. It also stipulates the safety requirements of electricity supply, electricity wiring and electrical products, etc.

There are several subsidiary regulations of the Electricity Ordinance, including:

1. Electricity Supply Regulations
2. Electricity Supply (Special Areas) Regulations
3. Electricity (Exemption) Regulations
4. Electricity (Registration) Regulations
5. Electricity (Wiring) Regulations
6. Electrical Products (Safety) Regulation
7. Electricity Supply Lines (Protection) Regulation

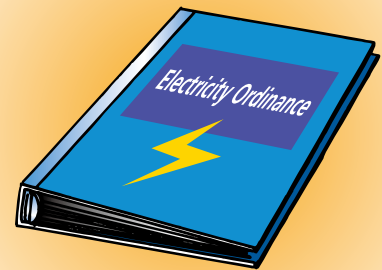

2.2 Factories and Industrial Undertakings (Electricity) Regulations

The Regulations apply to industrial undertakings in which electricity is generated, transformed, distributed or used. The purpose is to supervise the safety of electrical facilities and working processes, etc. of relevant industry.

2.3 Accident Statistics

These table reviews the industrial accident statistics involving electricity in the past decade.

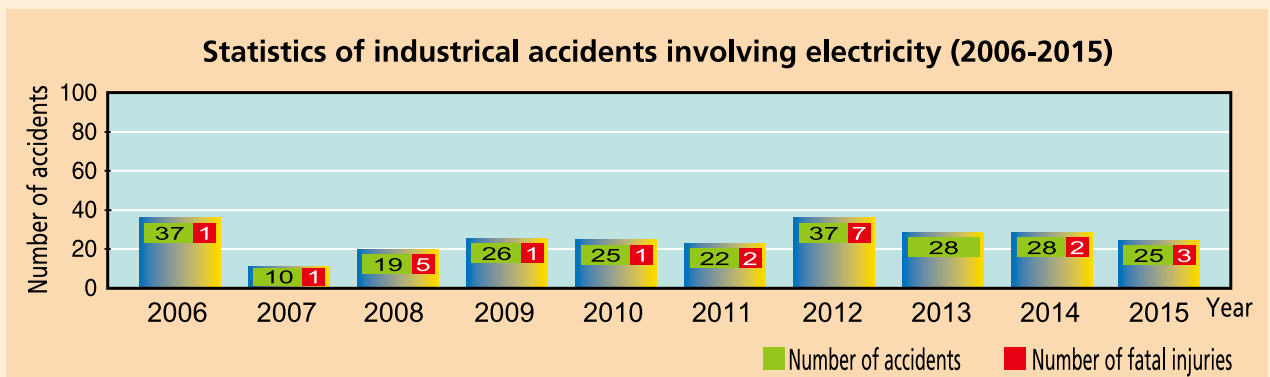



3. Sources of electricity

The electricity we used is mainly supplied by local electricity companies, and is connected to our homes, working places and other areas, through distribution systems.

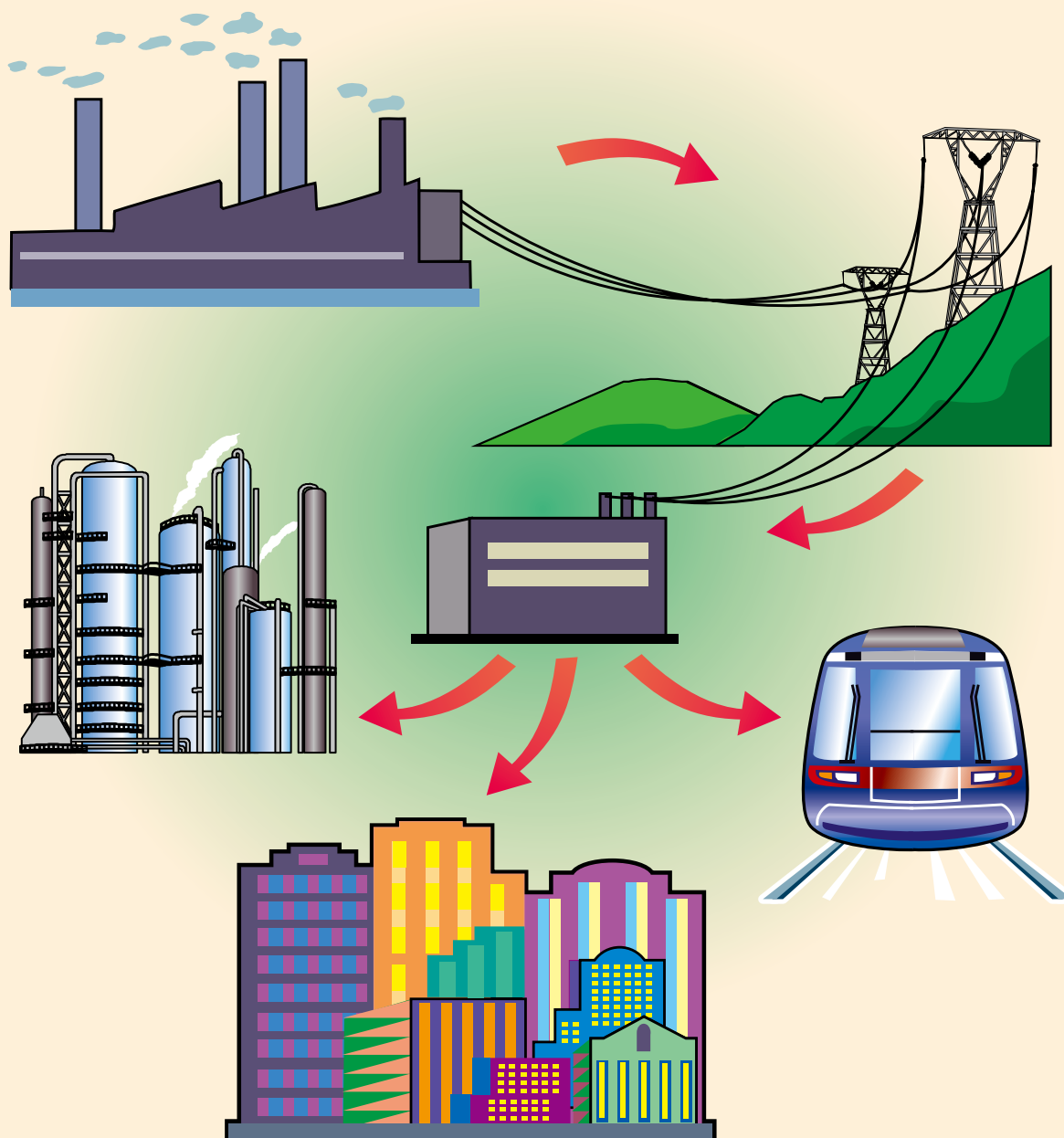

Frequency: 50 Hz

Voltage: Single-phase: 220 Volts (V) alternating current

3-phase: 380 Volts (V) alternating current

The electricity used in our homes and offices is single-phase alternating current, and 3-phase alternating current normally serves the industry.



4. Electricity principles



Ohm's Law

A complete electrical circuit is composed of 3 elements: Current, Voltage and Resistance.

Element	Unit	Abbreviation
Voltage (V)	Volts	V
Current (I)	Amperes	A
Resistance (R)	Ohms	Ω

Their correlative relationship can be shown by the following formula:

$$V = I \times R$$

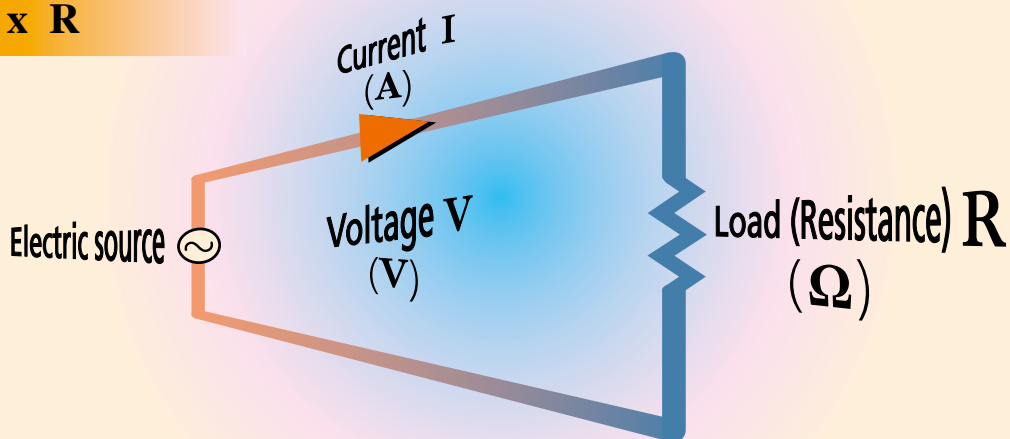

The above formula applies to the human body during an electric shock, provided that the voltage remains constant and there is Resistance (R) in the human body. A reduction in resistance in the human body will lead to higher electrical currents passing through it, and any injury will be more serious.

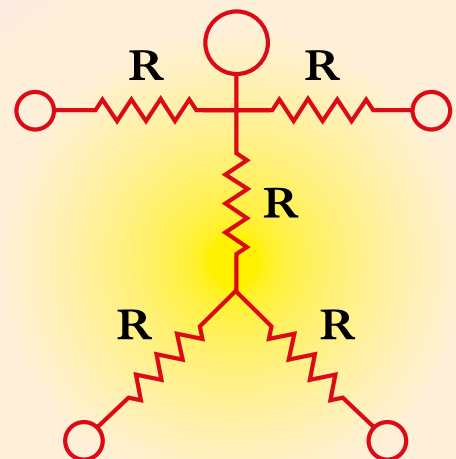



5. Electrical hazards



5.1 Electric shock

Electric shock refers to the electricity passing through the human body, affecting the normal function of the heart, lungs and nervous system. Ventricular fibrillation caused by electricity is the main reason for death from electric shocks. Electric shocks may indirectly lead to accidents, e.g. falling from heights and bruising due to body trauma etc.

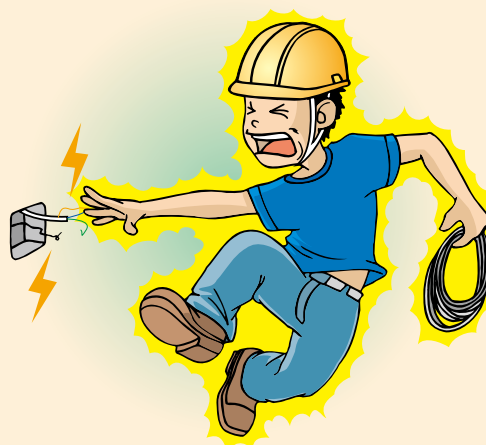

Ventricular fibrillation involves a series of disordered contractions of the heart's ventricular muscle fibres, which prevents regular heartbeat. Under normal conditions, the human heart rate is from around 60 to 100 times per minute. During an electric shock, heartbeat may increase up to several hundred times per minute. When the heart cannot sustain such rapid contraction and relaxation, it may stop beating and cause death.

The effect of currents passing through various parts of the body

Respiratory Failure

Electric shock may affect normal brain function and stop respiration.

Heartbeat Failure

If current passes through the heart, it will disrupt the rhythmic pumping action and eventually stop the heart beat.

Suffocation

Most accidents due to electric shocks are caused by current passing through the chest. When such accidents occur, chest muscles cramp, leading to suffocation and death.

Unable to get free after an electric shock

An electric shock causes continuous contraction of the forearm muscles, thus stopping the victim getting free from the electric source.

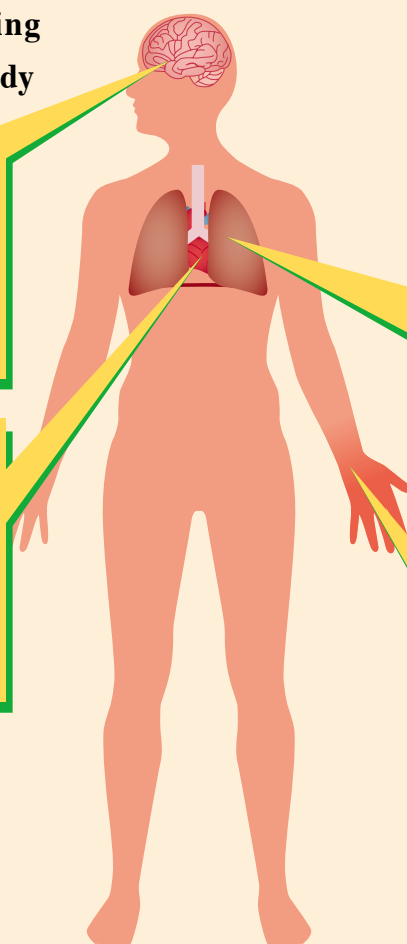

5.2 Burns

During an electric shock, the current passing through the body may lead to burns on the skin, muscles or internal organs. As electric shocks and burns are closely related, preventative measures should be considered together.

5.3 Fires and explosions

High temperatures caused by currents under abnormal conditions, may result in accidental fires and explosions. The common causes leading to high temperatures include:

- **Overloading of electricity**
- **Insulator breakdowns or short circuits**
- **Improper contact of electrical circuit**
- **Improper maintenance of electrical appliances or wiring**
- **Poor ventilation, etc.**

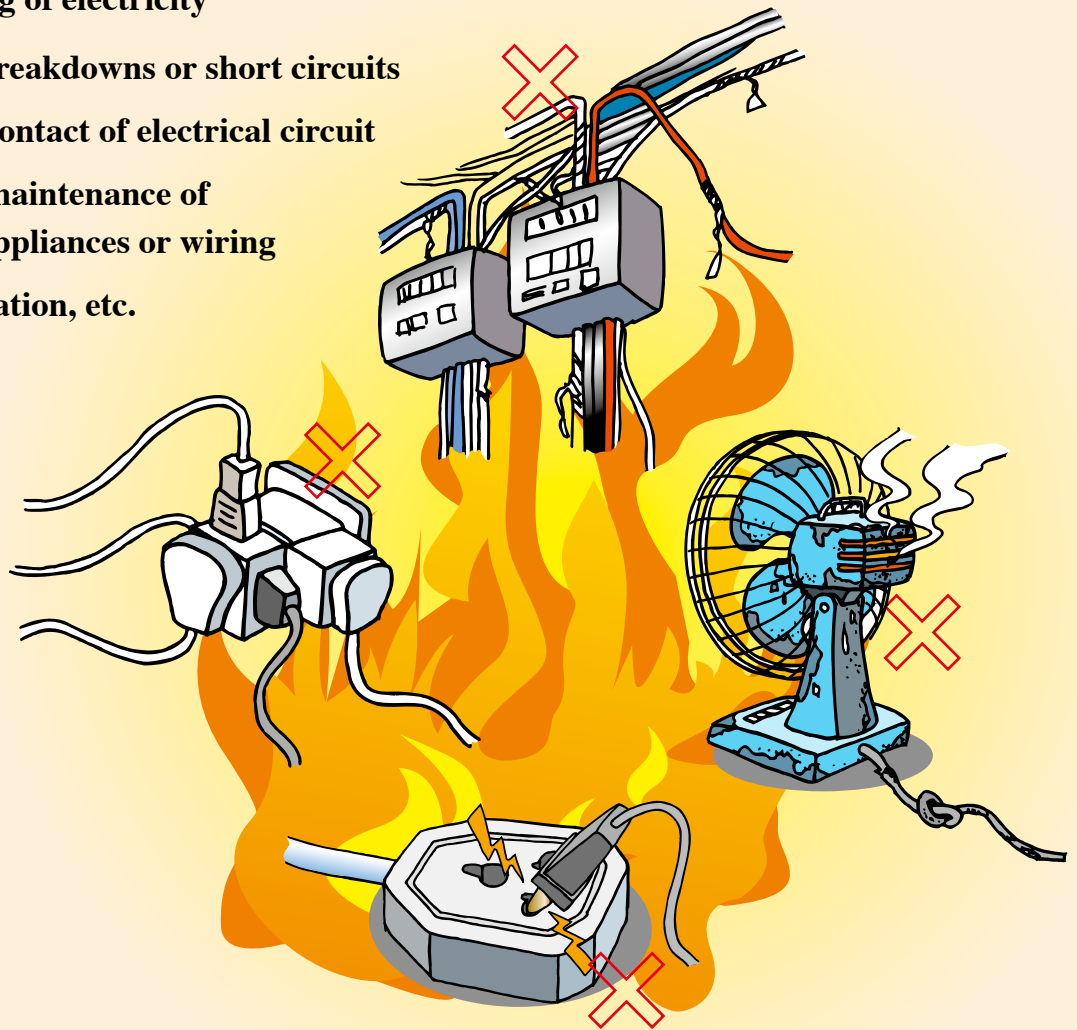

If flames, sparks or metallic solutions due to electric arc welding are not controlled, hazardous fires or explosions can occur.



6. Special process (electric arc welding)

Electric arc welding is commonly used for metallic welding and cutting. The various hazards from welding or cutting include the following:

Hazards

- **Burns**
Sparks or hot metal fragments from arc welding or cutting may result in serious burns. Proper protection is essential.

- **Radiation**
If proper eye protectors are not used while welding or cutting, radiation or other objects may hurt the welder.

Safety measures:

Wear proper personal protective equipment, e.g. approved eye protectors, hand shields, leather aprons, leather gloves and safety shoes, etc.



- **Electric shock**
It is dangerous to conduct the arc welding in a wet environment or on rainy days.

Safety measures:

- Avoid electric welding in such conditions.
- Earth the tools and equipment properly.
- Adjust the current required for welding to the minimum amount.
- Add an automatic voltage regulator to reduce the open-circuit no-load voltage of the transformer output, reducing the chance of getting an electric shock.

- **Poisonous fumes and gases**
Inhalation of poisonous fumes and gases during welding or cutting may cause serious health problems.

Safety measures:

- Provide adequate ventilation.
- Use exhaust systems to remove poisonous fumes and gases.

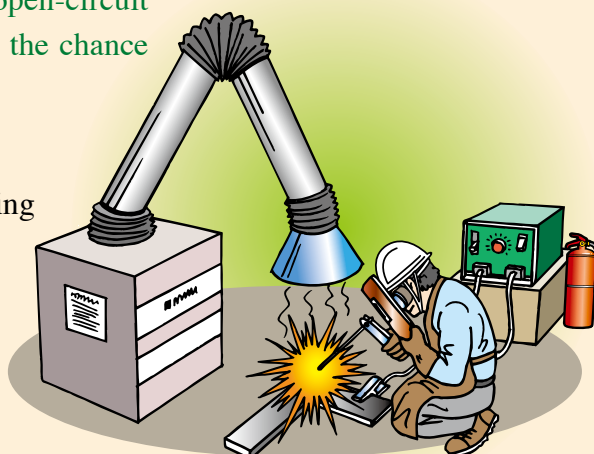

7. Protective measures for prevention of direct electrical contact

The following procedures will prevent the human body from contact with electrical conductors, wiring, electrical sources, etc.

Protective measures

- **Insulation**
Shield the electrical conductor with an insulator to prevent direct contact
- **Barriers or enclosures**
Create barriers or enclosures that prevent any direct contact with the electrical conductor
- **Obstacles**
Place obstacles to prevent any accidental contact with the electrical conductor
- **Placing out of reach**
This prevents accidental contact with the electrical conductor

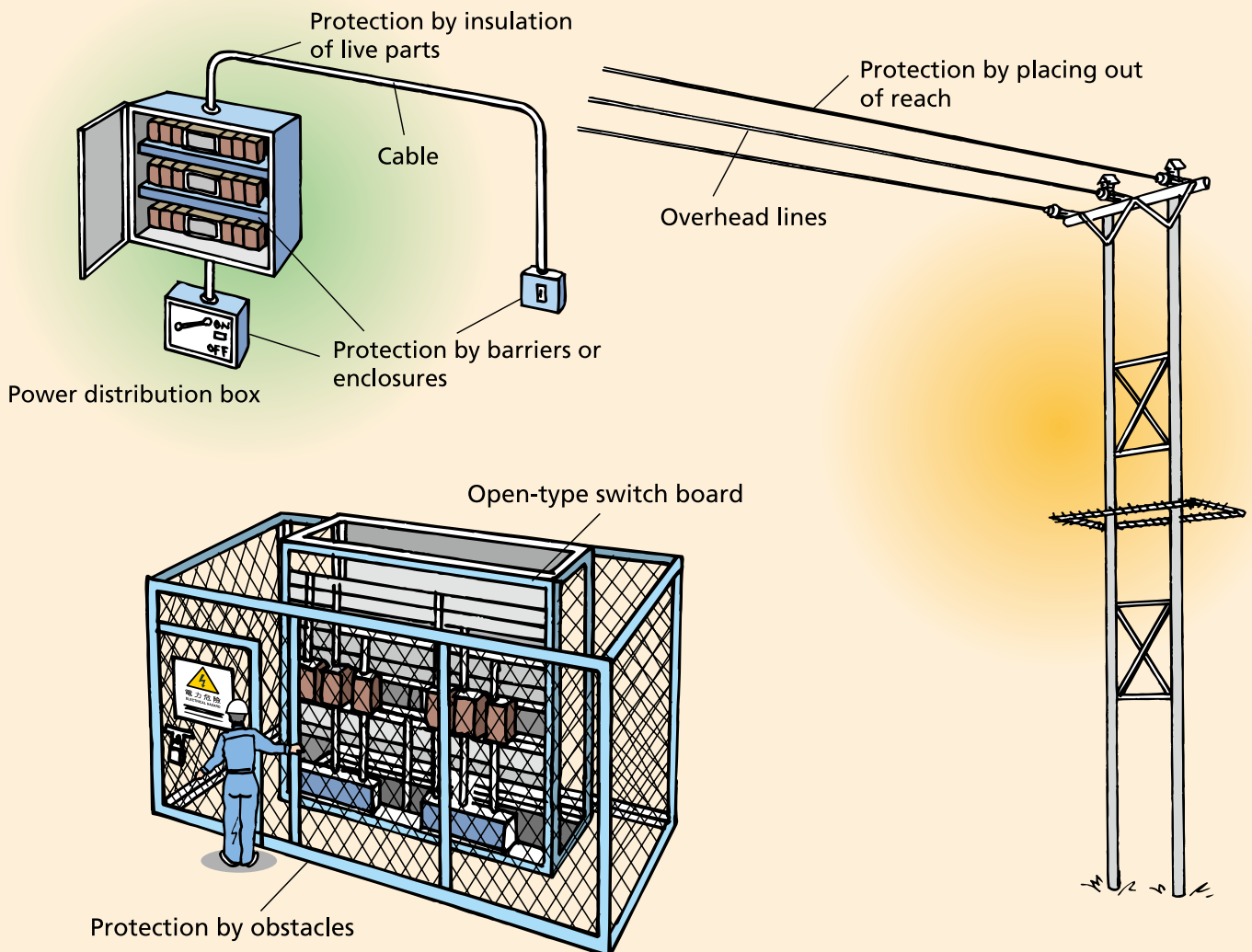



8. Safety devices

8.1 Fuse

Normally, a fuse is a copper wiring with a set current fusion value. If the current exceeds the set fusion value, the fuse will blow and the current is cut-off, thus preventing overloading.

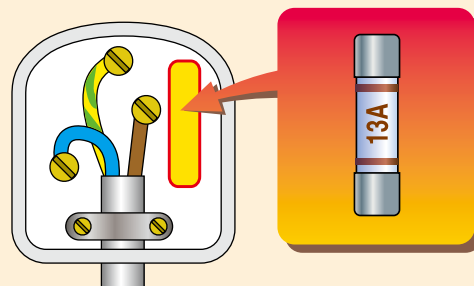

A fuse must be installed on “live” wires. When replacing a fuse, the new fuse must be same current fusion value as the old one.

8.2 Circuit breakers (MCB)

Circuit breakers are based on the principle of the electromagnetic field. The current entered may enable the coils of the circuit breaker to magnetise. When the current exceeds the set value (i.e., overloading), the magnetisation intensifies, switching off the circuit breaker and disconnecting the electric source.

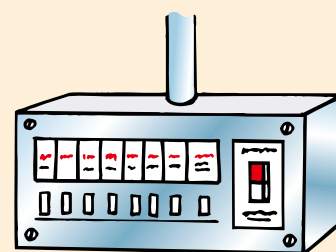

8.3 Earthing

Earthing provides a low resistance way of discharging electricity to the ground in case of current leakage. This means that during an electric shock, the current passes through the “earth” wire and is prevented from entering the human body and causing injury.

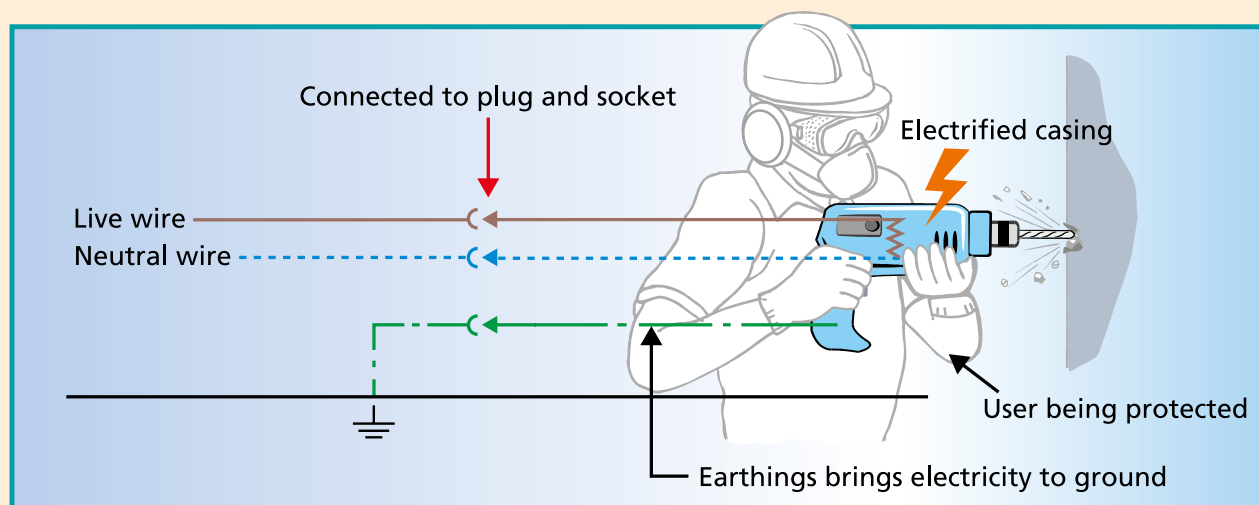

8.4 Earth leakage circuit breaker (ELCB or RCD)

Current leakage protection is also called residual current protection or earthing fault current protection. Earth leakage circuit breakers monitor the operation of the “neutral” or “live” wires in the electrical circuit. During an imbalance in the electrical circuit, or when not all the current flows to the electrical appliance through the “live” wire and returns through the “neutral” wire, part of the current flows away (leaks) into other sources. The earth leakage circuit breaker will immediately detect such an imbalance and cut-off the electrical source in 0.4 seconds. Rating of the tripping current shall not exceed 30mA.

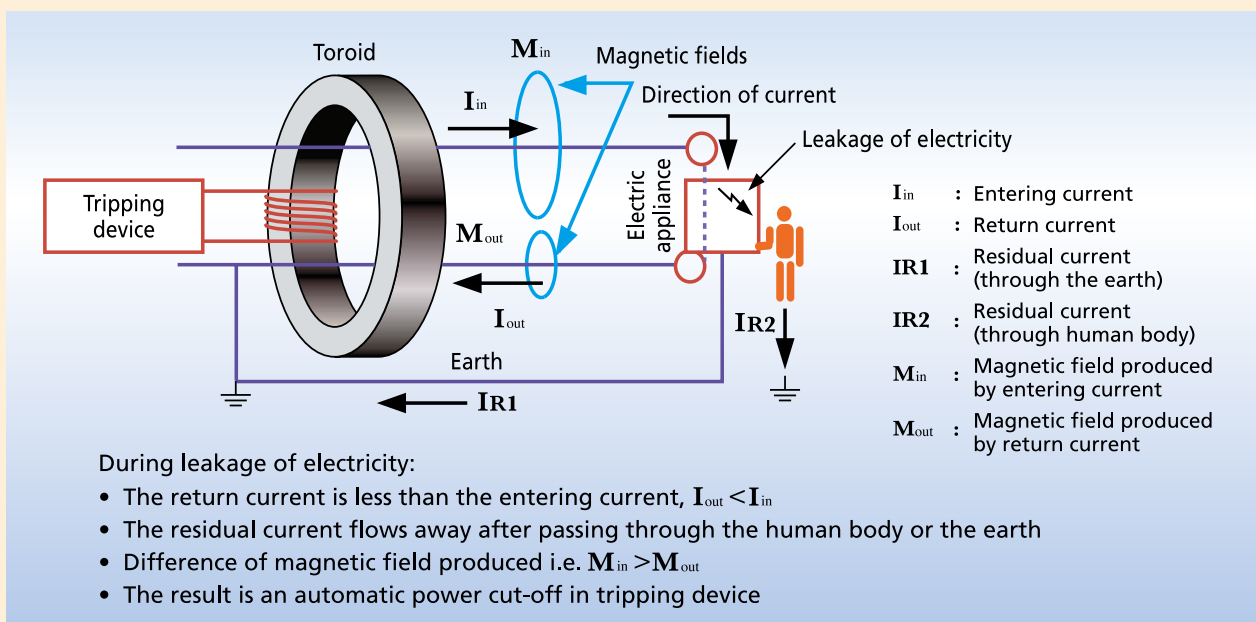

If ELCB is not fixed in main circuit box or the worker works in high risk environment (E.g. humid condition), portable RCD(Residual Current Devices) should be installed to reduce the chance of getting an electric shock.



8.5 Double insulation

An electrical appliance with double insulation is protected by a supplementary insulation layer in addition to basic insulation. Electrical appliances with double insulation bear the “” mark. No earth connection is required for such appliances since double insulation provides sufficient protection.

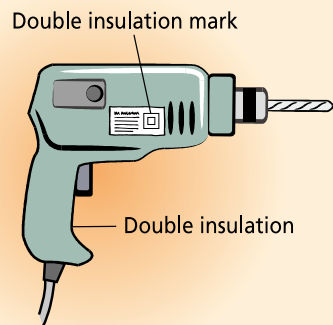

8.6 Extra-low voltage

Using electrical tools with an extra-low voltage of less than 50 V may minimise injury in case of electric shock. When extra-low voltage is used, an earthing connection may not be required.



9. Safe use of electricity

9.1 Safe use of plugs

9.1.1 Specification of electric plugs

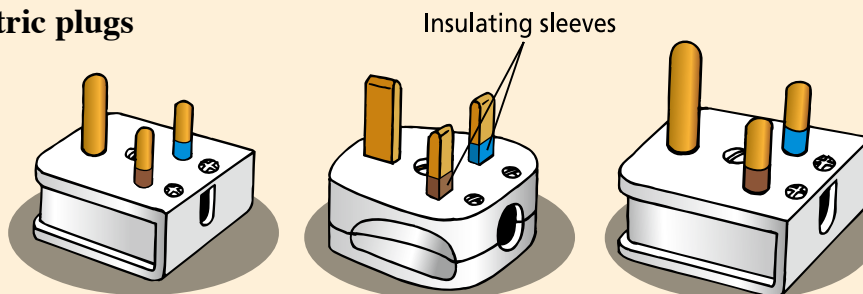

Rating	5-Ampere plug	13-Ampere plug	15-Ampere plug
Standard	BS 546	BS 1363	BS 546

- Plugs for electrical equipment shall match the power/current rating (calculated by voltage 220V).

Maximum power Watt (W)	1100	2860	3300
---------------------------	------	------	------

9.1.2 Connection of plugs

Electrical and Mechanical Services Department announced the new colour code for those electrical installation works on or after 1 July 2007. From now on, new colour code should be used for all new electrical installation works.

Function	Colour		Letter Code
	Old Colour Code	New Colour Code	
Phase of single phase circuit	red (or yellow or white or blue)	brown	L
Phase 1 of 3-phase circuit	red	brown	L1
Phase 2 of 3-phase circuit	yellow or white	black	L2
Phase 3 of 3-phase circuit	blue	grey	L3
Neutral	black	blue	N
Protective conductor	green or yellow	green or yellow	--

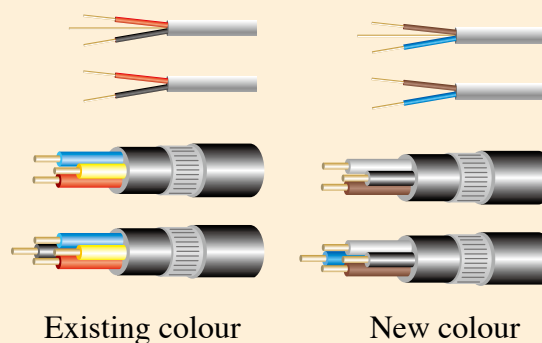

小心！

此電力裝置包含新舊顏色的電線。在進行加裝、改裝或修理工前，務須正確識別所有導體。

CAUTION!

THIS INSTALLATION HAS BOTH NEW AND OLD CABLE COLOURS. GREAT CARE SHOULD BE TAKEN BEFORE UNDERTAKING EXTENSION, ALTERATION OR REPAIR THAT ALL CONDUCTORS ARE CORRECTLY IDENTIFIED.

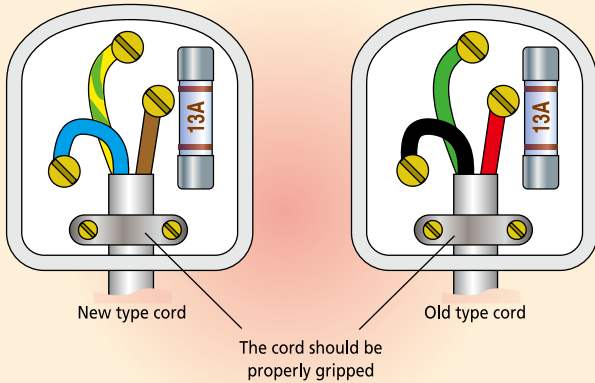

Brown or red to Live (L)
 Blue or black to Neutral (N)
 Yellow/green or green to Earth (E or \perp)

9.1.3 Safety hints

- Use correct plugs. Never insert the core of the cord directly into a socket.

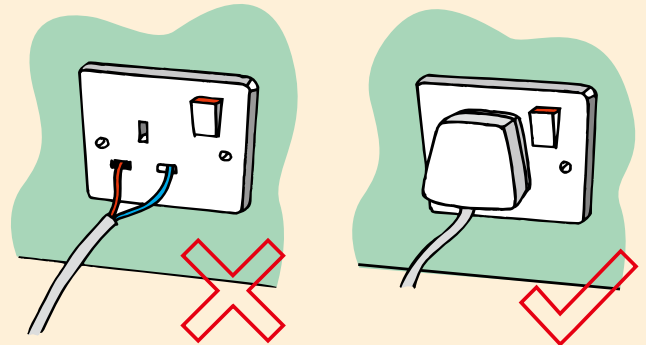

- Unplug by pulling the plug - not the cord.

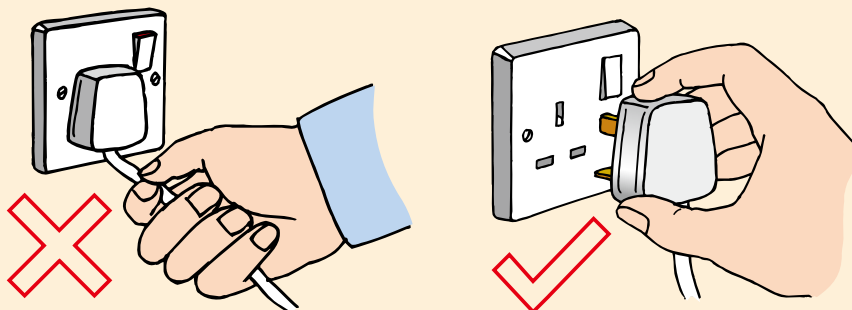

- Do not touch the plug with wet hands, as wet skin reduces the resistance of the body, resulting in more serious injuries.

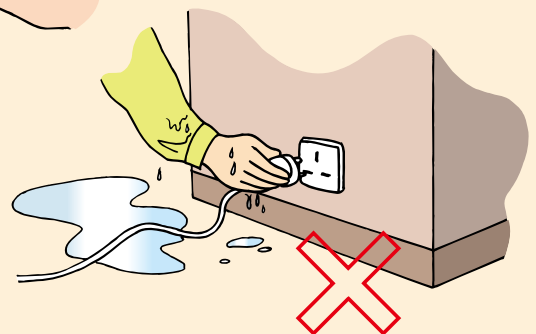

- Broken plugs must be replaced immediately.

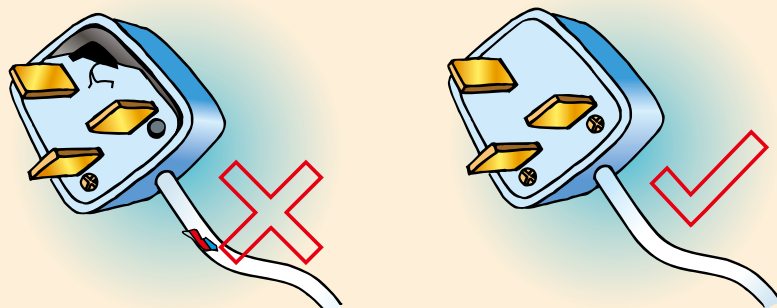



- Avoid overloading! Never put too many plugs into the same socket.

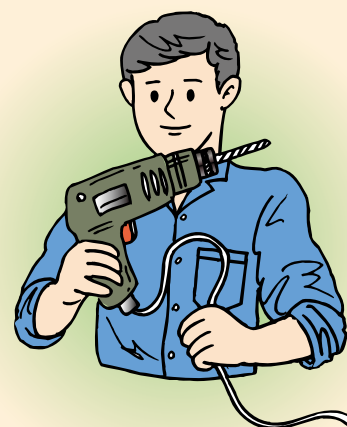

9.2 Hints on safe use of electricity

- Inspect electrical tools before use. Stop using unsafe tools.



- Place trailing cables well in order to avoid tripping.

- Use the mobile working platform with proper grounding or use light duty working platform (step platform and hop-up platform) made of non-conductive materials.



- Electrical-based work must not be carried out near flammable substances: especially electric arc welding.

- In a wet working environment or when working outdoors, waterproof plugs and cables must be used.

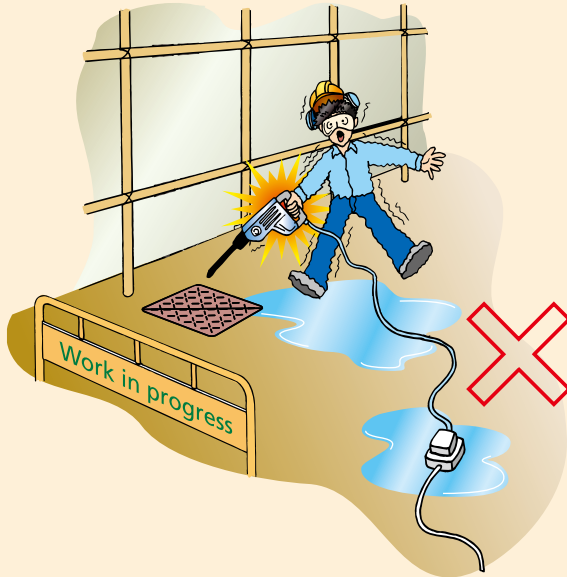

- Before maintaining electrical appliances, all switches must be turned off and relevant cables unplugged.

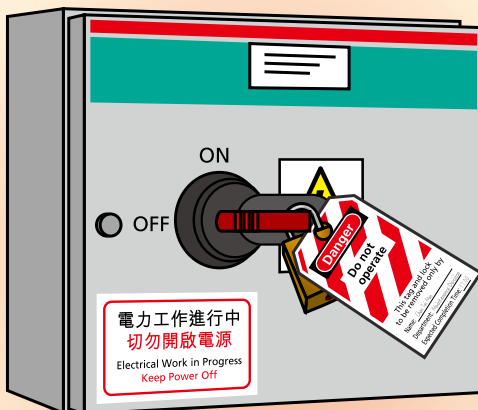

- Before carrying out high risk or large-scale machinery maintenance, the main switch should be turned off. The power source must be locked and labeled with warning signs, so as to avoid any confusion when reconnecting the power. Implement “Pointing and Calling” procedure to counter check the safety measures must be properly executed.

- Ensure that all electrical installations, equipment and appliances are regularly repaired and maintained by registered electrical workers.

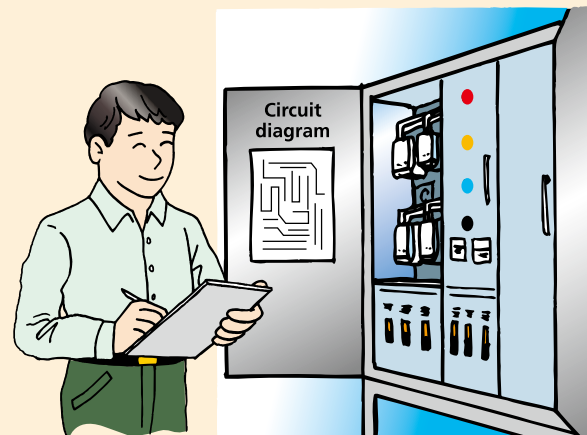



⊕ 10. Installation and maintenance of electrical work ⊖

The installation and maintenance of electrical work must be carried out by the registered electrical workers. “Electrical work” means the work in relation to the installation, commissioning, inspection, testing, maintenance, modification or repair of relevant projects or work of high or low voltage fixed electrical installation. Those engaged in projects of non-fixed electrical installation (e.g. repair of table lamps, televisions, refrigerators, etc.) are not required to be registered.



The classification of the license of electricians:

Grade A Electrical Work

Electrical work on a low voltage fixed electrical installation not exceeding 400 Amperes (single-phase or 3-phase).

Grade B Electrical Work

Electrical work on a low voltage fixed electrical installation not exceeding 2500 Amperes (single-phase or 3-phase).

Grade C Electrical Work

Electrical work on a low voltage fixed electrical installation of any capacity.

Grade R Electrical Work

Include any one or more of the following types of installations:

1. Neon sign installation.
2. Low voltage air-conditioning installation.
3. Low voltage power generating facility installation, etc.

Grade H Electrical Work

Electrical work on a high voltage electrical installation.

- **Extra-low voltage**

Means voltage between conductors or between any conductor and earth with Alternating Current (AC) not exceeding 50 V or Direct Current (DC) not exceeding 120 V.

- **Low voltage**

Means voltage normally exceeding extra-low voltage, but between conductors with AC not exceeding 1000 V or DC not exceeding 1500 V, or the voltage between conductors and earth with AC not exceeding 600 V or DC not exceeding 900 V.

- **High voltage**

Means voltage normally exceeding low voltage, but between conductors with AC exceeding 1000 V or DC exceeding 1500 V, or the voltage between conductor and earth with AC exceeding 600 V or DC exceeding 900 V.





11. First-aid for electric shock



If anyone suffers an electric shock, the electricity source should be cut off immediately. Only conduct the first-aid when the victim is in a safe place. Check the victim's breath and pulse. If the person is unconscious but is breathing normally, he or she should be placed in a recovery position. If the victim is not breathing and has no pulse, cardiopulmonary resuscitation should be conducted.

Note: Cardiopulmonary resuscitation should be carried out only by competent first-aid personnel.

Cardiopulmonary resuscitation

Treatment:

1 Open the AIRWAY

Lift the jaw and tilt the head back to open the airway. Clear any obstacles.



2 Check the BREATHS

See : See if the chest rises and falls.

Listen : Listen for breathing.

Feel : Feel breathing on your cheek.



3 Check the pulse (CIRCULATION)

Use your fingers to feel the pulse.



4 Recovery position

If the casualty is unconscious but is breathing normally, place them in the recovery position. (as shown in figure below)



5 Mouth to mouth expired air resuscitation

If the person is not breathing, mouth-to-mouth resuscitation should be used to help the resumption of breathing.



6 External chest compression

If the casualty has no pulse, cardiopulmonary resuscitation should be carried out (combining the expired air resuscitation and external chest compression).

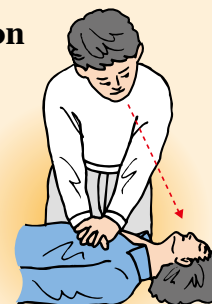

For all premises apply on Factories and Industrial Undertaking Ordinance, the treatment notice of persons receiving electric shock in Chinese and English shall be displayed in all parts of the premises where electricity is generated, transformed, or used.



Name of organisation: _____

Work place: _____

Date: _____ Time: _____ Name of inspector/Signature: _____

The following list is a sample of regular inspections to be carried out by relevant organizations. The content is subject to appropriate modifications based on of the organisation's working environment.

1. Electrical installation

Inspection content	Satisfactory	Improvement required	Immediate improvement required	N/A	Follow-up action
1.1 Were all electrical installation carried out by competent electricians?	<input type="checkbox"/>	<input type="checkbox"/>	<input type="checkbox"/>	<input type="checkbox"/>	
1.2 Is a circuit breaker or suitable fuse installed?	<input type="checkbox"/>	<input type="checkbox"/>	<input type="checkbox"/>	<input type="checkbox"/>	
1.3 Is an earth leakage circuit breaker installed?	<input type="checkbox"/>	<input type="checkbox"/>	<input type="checkbox"/>	<input type="checkbox"/>	
1.4 Is the poster of 'First-Aid For Electric Shocks' displayed?	<input type="checkbox"/>	<input type="checkbox"/>	<input type="checkbox"/>	<input type="checkbox"/>	
1.5 Have there been any regular repairs and maintenance?	<input type="checkbox"/>	<input type="checkbox"/>	<input type="checkbox"/>	<input type="checkbox"/>	

2. Electrical appliances and equipment

Inspection content	Satisfactory	Improvement required	Immediate improvement required	N/A	Follow-up action
2.1 Do the plugs meet the legislative requirement?	<input type="checkbox"/>	<input type="checkbox"/>	<input type="checkbox"/>	<input type="checkbox"/>	
2.2 Is the electricity overloaded?	<input type="checkbox"/>	<input type="checkbox"/>	<input type="checkbox"/>	<input type="checkbox"/>	
2.3 Is there suitable dissipation for the electrical appliances and equipment?	<input type="checkbox"/>	<input type="checkbox"/>	<input type="checkbox"/>	<input type="checkbox"/>	
2.4 Is the earth wire correctly connected?	<input type="checkbox"/>	<input type="checkbox"/>	<input type="checkbox"/>	<input type="checkbox"/>	
2.5 Are there any cables lying on the ground?	<input type="checkbox"/>	<input type="checkbox"/>	<input type="checkbox"/>	<input type="checkbox"/>	



3. Portable electrical tools

Inspection content	Satisfactory	Improvement required	Immediate improvement required	N/A	Follow-up action
3.1 Are the portable electrical tools connected to the earth or are they double insulation for protection?	<input type="checkbox"/>	<input type="checkbox"/>	<input type="checkbox"/>	<input type="checkbox"/>	
3.2 Do the portable electrical tools use extra-low voltage?	<input type="checkbox"/>	<input type="checkbox"/>	<input type="checkbox"/>	<input type="checkbox"/>	
3.3 Do the plugs meet legislative requirements?	<input type="checkbox"/>	<input type="checkbox"/>	<input type="checkbox"/>	<input type="checkbox"/>	
3.4 Is there any damage to the insulator and cables?	<input type="checkbox"/>	<input type="checkbox"/>	<input type="checkbox"/>	<input type="checkbox"/>	
3.5 Is the working environment wet?	<input type="checkbox"/>	<input type="checkbox"/>	<input type="checkbox"/>	<input type="checkbox"/>	

4. Special process (electric arc welding)

Inspection content	Satisfactory	Improvement required	Immediate improvement required	N/A	Follow-up action
4.1 Is the working place close to where flammable substances are stored?	<input type="checkbox"/>	<input type="checkbox"/>	<input type="checkbox"/>	<input type="checkbox"/>	
4.2 Are the tools and work pieces correctly earthed?	<input type="checkbox"/>	<input type="checkbox"/>	<input type="checkbox"/>	<input type="checkbox"/>	
4.3 Are the welders provided with suitable personal protective equipment and are they correctly used?	<input type="checkbox"/>	<input type="checkbox"/>	<input type="checkbox"/>	<input type="checkbox"/>	
4.4 Is the ventilation in good condition?	<input type="checkbox"/>	<input type="checkbox"/>	<input type="checkbox"/>	<input type="checkbox"/>	
4.5 Are there water puddles in the working place or is the environment wet?	<input type="checkbox"/>	<input type="checkbox"/>	<input type="checkbox"/>	<input type="checkbox"/>	

5. General

Inspection content	Satisfactory	Improvement required	Immediate improvement required	N/A	Follow-up action
5.1 Are waterproof cables and plugs used outdoors?	<input type="checkbox"/>	<input type="checkbox"/>	<input type="checkbox"/>	<input type="checkbox"/>	
5.2 Are the ladders made of non-conductive materials?	<input type="checkbox"/>	<input type="checkbox"/>	<input type="checkbox"/>	<input type="checkbox"/>	
5.3 Are there any signs of damage or overheating to the cables, plugs, sockets, etc.?	<input type="checkbox"/>	<input type="checkbox"/>	<input type="checkbox"/>	<input type="checkbox"/>	
5.4 Is the power to the electrical appliances and portable electrical tools turned off before carrying out maintenance work and are the warning signs displayed?	<input type="checkbox"/>	<input type="checkbox"/>	<input type="checkbox"/>	<input type="checkbox"/>	
5.5 Are all places that are liable to fire hazards provided with fire fighting equipment, e.g. fire extinguishers?	<input type="checkbox"/>	<input type="checkbox"/>	<input type="checkbox"/>	<input type="checkbox"/>	



19/F, China United Centre, 28 Marble Road,
North Point, Hong Kong

Tel : 2739 9377 Fax : 2739 9779

Email : oshc@oshc.org.hk

Hotline : 2739 9000

SafeFax : 2316 2576

Website : www.oshc.org.hk



ISBN 978-962-968-493-8

